



The Advance Xtanium Sensor Ready (SR) LED driver can help reduce complexity and cost of light fixtures used in connected lighting systems in outdoor lighting applications. It's D4i certified and features a standard-compliant digital interface to enable direct connection to compatible networked lighting control (NLC) solutions. Functionality that ordinarily would require additional auxiliary components is integrated into the driver. The result is a simple, cost-effective light fixture that can enable every fixture to become a wireless node.

### Specifications

Input Voltage (Vrms)	Output Power (W)	Output Voltage (V)	Output Current (A)	Efficiency@ Max. Load and 70°C Case	Max. Case Temp. (°C)	Input Current (Arms)	Max. Input Power (W) <sup>1</sup>	THD @ Max. Load	Power Factor @ Max. Load	Surge Protection Common/Diff (KV)	Envir. Protection Rating	Dim.	Dimming Range	Min. Output Current (A)
120	180	50 - 144	0.1A -1.8A	91	Life: 85°C UL: 90°C	1.76	212	<10%	>0.95	6	UL damp & dry	DALI	10% ~ 100%	0.1
227				93		0.76		<15%						

### Enclosure

	In. (mm)	Tolerance
Case Length (L2)	8.31 (211.1)	± 0.5mm
Case Width (W)	2.31 (58.6)	± 0.5mm
Case Height (H)	1.48 (37.6)	± 0.5mm
Mounting Length (M)	8.91 (226.3)	± 0.5mm
Overall Length (L1)	9.45 (240.0)	± 0.5mm
Center of SimpleSet Antenna (L3)	3.75 (95.3)	± 0.5mm

### Wiring Diagram

	Wire Length (mm)
Black/Orange (Line)	270 (± 30)
Black/White (Neutral)	270 (± 30)
Red (Positive, LED output)	270 (± 30)
Blue (Negative, LED output)	270 (± 30)
Violet/White (Positive, DA+)	270 (± 30)
Gray/White (Negative, DA-)	270 (± 30)
Brown(Positive +24V)	270 (± 30)
Orange(Logical Signal Input)	270 (± 30)

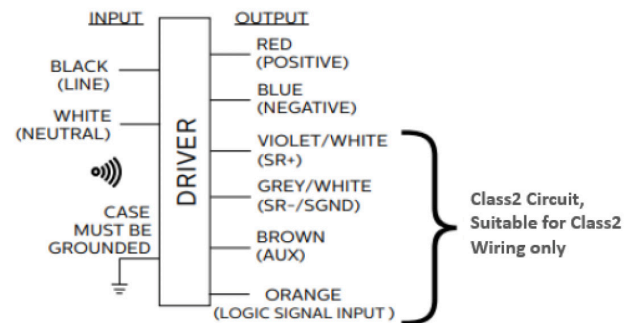
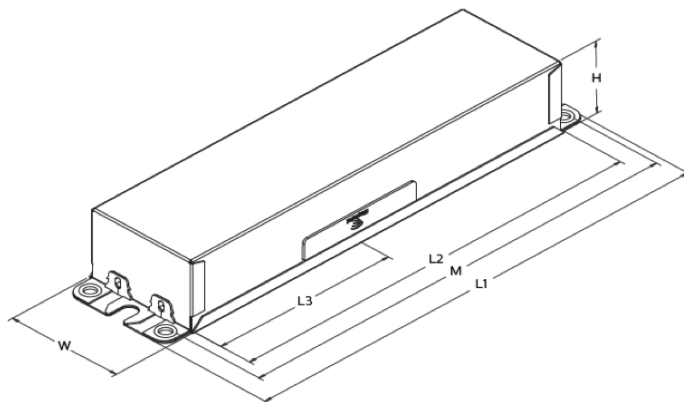

1. Based on 3W Auxiliary Power Supply Loading

# Xitanium SR XI180C180V144VSF2

## 180W 120-277 1.8A SR with Auxiliary Supply

### Electrical Specifications

All the specifications are typical and at 25°C Ta unless specified otherwise.

#### Features

- Standard-compliant (ANSI C137.4 and DiiA) digital interface including:
  - Integrated DALI bus power supply (Part 250)
  - Memory Bank 1 extension, Energy Monitoring and Diagnostics (Parts 251, 252, 253)
  - 24V Auxiliary power supply for higher power device requirements (Part 150)
- Accurate energy metering
- Logic Signal Input (LSI)
- Drive current setting via SimpleSet (wireless)
- 5-year limited warranty<sup>1</sup>

- Enables interoperability with compatible third-party networked lighting control (NLC) solutions
- Reduces cost and complexity of outdoor connected lighting systems<sup>2</sup>
- Standardized luminaire data for Asset Management
- 2% metering accuracy meets proposed ANSI standard C136.52
- Can be used with standard motion sensors for local control to complement network control

#### Application

- Site & area
- Parking garages
- Floodlights
- Roadways
- Industrial warehouses

#### Benefits

#### Product Data

Ordering Information	
Order Code	XI180C180V144VSF2M (Mid-Pack, 10pcs/Box), 12NC: 929002721613
GTIN	781087166536
Input Information	
Line Frequency	50/60Hz
Min. Mains Voltage Operational	108Vac
Max. Mains Voltage Operational	305Vac
Output Information	
Maximum Open Circuit Voltage	200Vdc
Output Current Ripple = (Pk-Avg)/Avg	< 15% @ max lout
Flicker	Meets NEMA 77
Output Current Tolerance (At Maximum Output Current)	<5%
Leakage Current of Control Circuit (SR,Aux and LSI)	0.5 mA
Protections	Short Circuit and Open Circuit Protection for LED + and LED-, Thermal foldback protection
Standby power@ 277vin	<0.5W <sup>3</sup>
Features	
AOC (adjustable output current)	0.1A-1.8A via SimpleSet (Factory Default at 0.7A)
Suitable for Outdoor Use?	Yes
Interfaces	Simpleset, Sensor Ready(SR), Logical Signal Input (LSI), Auxiliary Power Supply
Power Reporting Accuracy	+/-2% in performance window and under nominal operating conditions
Configurable Features	Advance Driver Thermal Limit, Dynadimmer, Password protection, and many others.
Auxiliary Power Supply (According to ANSI C137.4)	
Nominal Aux. Output Voltage	24Vdc
Rated Aux. Output Power	3W continuous, 6W peak
Protections	Short Circuit & Open Circuit Protection for Aux. + and Aux. -

1. Advance Xitanium LED drivers are designed and manufactured to engineering standards correlating to an average life expectancy of 50,000 hours of operation at maximum rated case temperature. Minimum 90% survivals based on MTTF modeling.
2. Functionality that ordinarily would require additional auxiliary components is integrated into the driver.
3. With No loading on control terminals and SR disabled.

# Xitanium SR XI180C180V144VSF2

180W 120-277 1.8A SR with Auxiliary Supply

## Electrical Specifications

All the specifications are typical and at 25°C Ta unless specified otherwise.

## Product Data (continued)

SR power supply	
Current Source	52mA to 60mA
Voltage Range	12V to 20V
Communication Protocol	DALI-2, D4i, ANSI C137.4
Mis-wiring to Mains Protection	No
Logic Signal Input (LSI)	
Dry Contact Input	Yes
Logic Low	<3V or open
Logic High	>7V
Max. Current Draw	2mA
Environment & Approbation	
Operating Ambient Temp. Range	-40°C to +55°C
Max Case Temperature (Tcase)	85°C for Life & 90°C for UL Safety
Agency Approbations	UL 8750, CSA 250.13, Class P (UL, CSA, ETL)
Electromagnetic Compliance	FCC Title 47 Part 15 Class A
Audible Noise	<24dB Class A
Weight	2.1Lbs/ 0.95Kgs
Envir. Protection Rating	UL Dry and Damp

# Xitanium SR XI180C180V144VSF2

180W 120-277 1.8A SR with Auxiliary Supply

## Electrical Specifications

All specifications are typical and at 25°C Ta unless specified otherwise.

## Dimming Characteristics

The Advance Xitanium SR drivers use a logarithmic dimming curve as default. Dimming is accomplished through the 2-wire SR interface to the sensor. The SR interface utilizes the DALI standard IEC62386\_102 Edition 2, which defines the logarithmic dimming curve. The SR interface also utilizes DALI standard IEC62386\_101 Edition 2, which defines the linear dimming curve as well as the command for switching between logarithmic and linear curves.

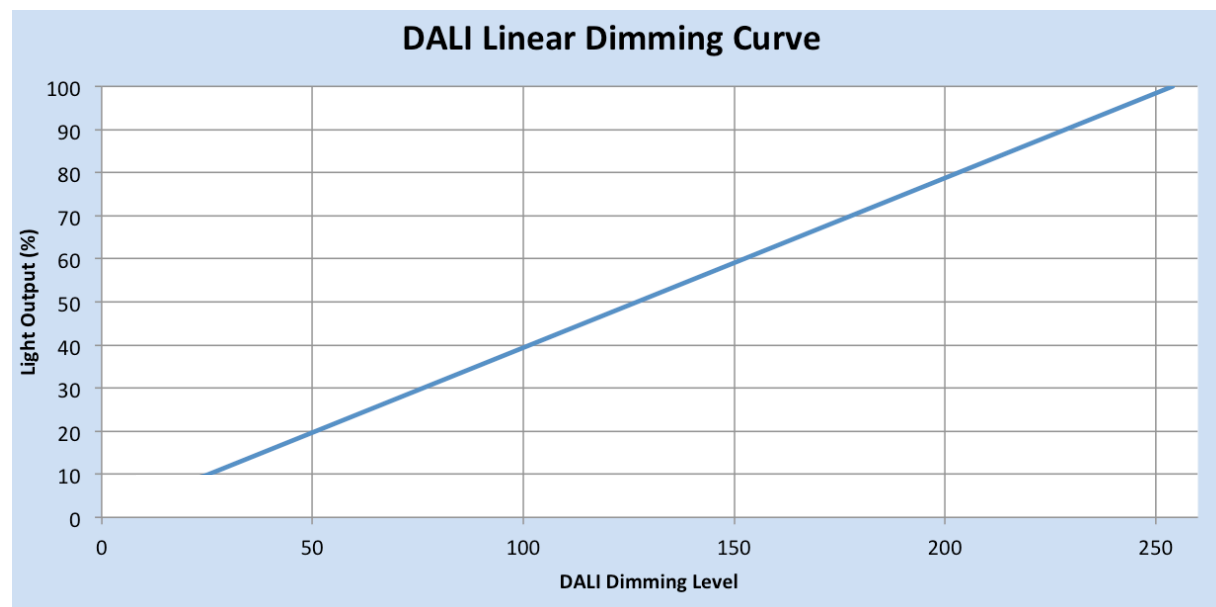
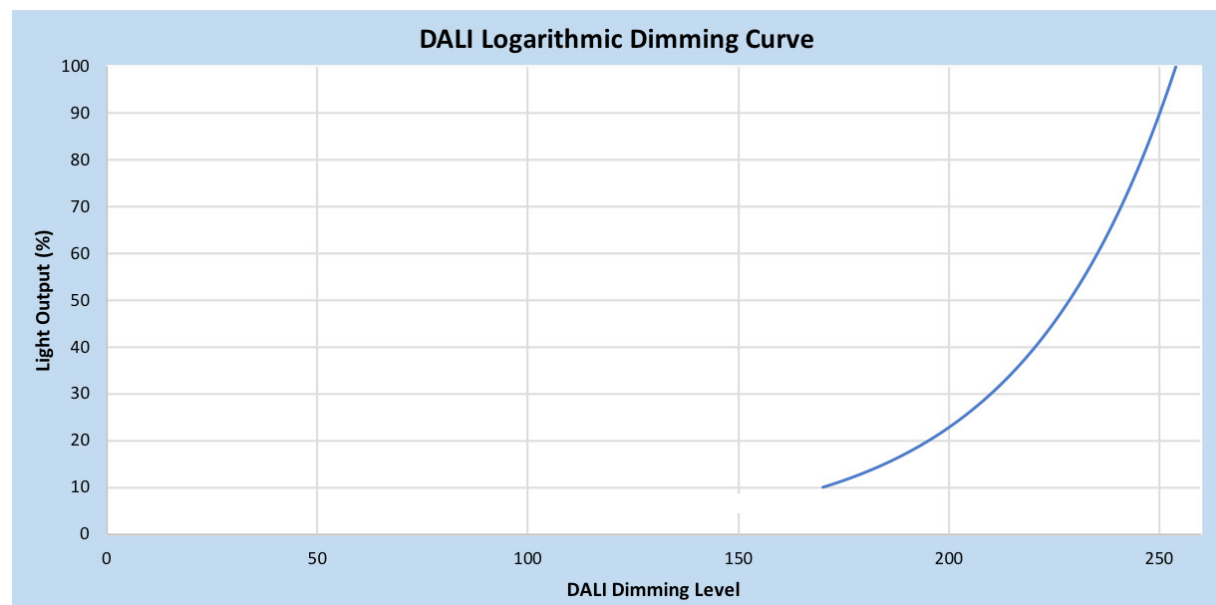

# Xitanium SR XI180C180V144VSF2

180W 120–277 1.8A SR with Auxiliary Supply

## Electrical Specifications

All specifications are typical and at 25°C Ta unless specified otherwise.

## Operating Window

The driver current cutback feature provides for an increased output voltage with a reduced output current during abnormal LED operation, such as cold weather starting. Output tolerance +/-5%.

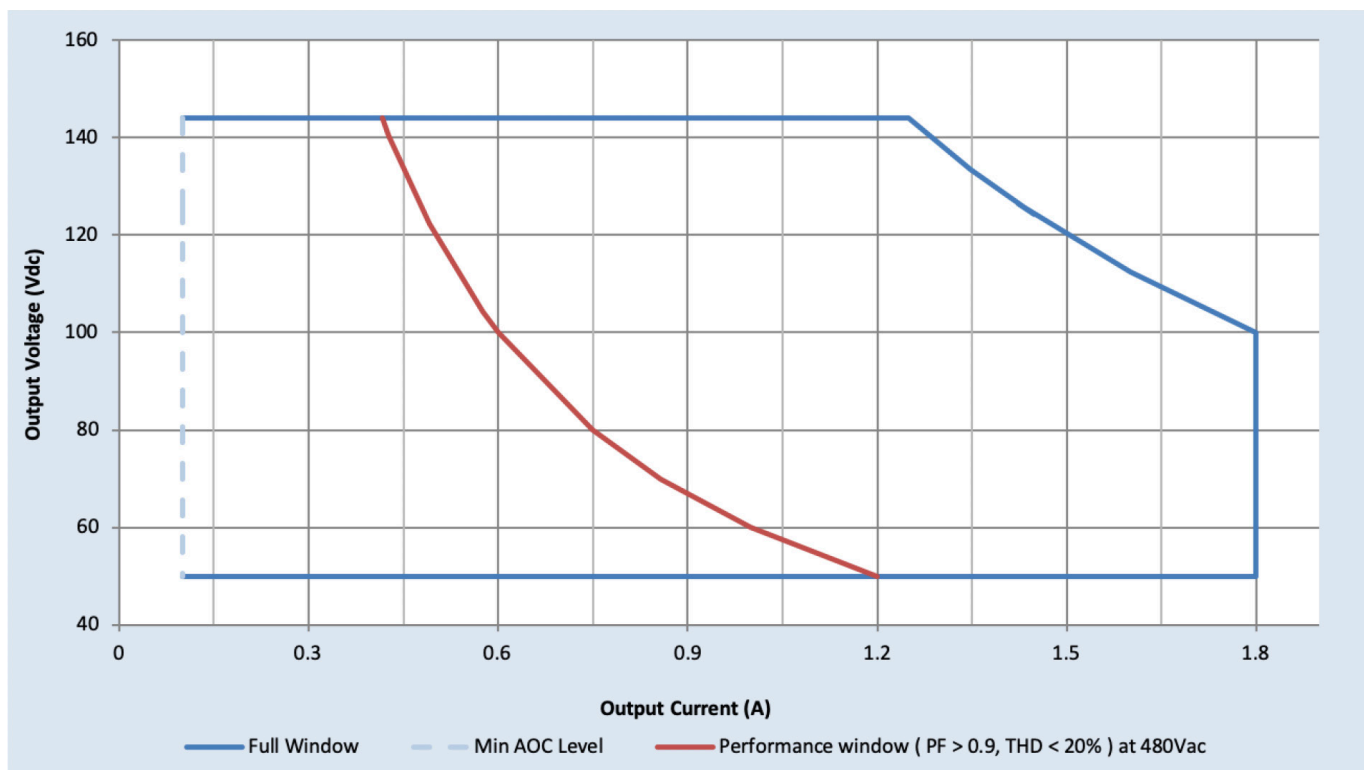

## Notes

1. Factory default output current is 1.5A.
2. To get a 100% to 10% dimming range, the output current setting through AOC should be  $\geq 1A$ .
3. Factory default minimum dimming level is 10%. This can be adjusted between 10% and 100% using Advance MultiOne.

# Xtanium SR XI180C180V144VSF2

180W 120-277 1.8A SR with Auxiliary Supply

## Electrical Specifications

All specifications are typical and at 25°C Ta unless specified otherwise.

### Logic Signal Input (LSI) Characteristics (Typical)

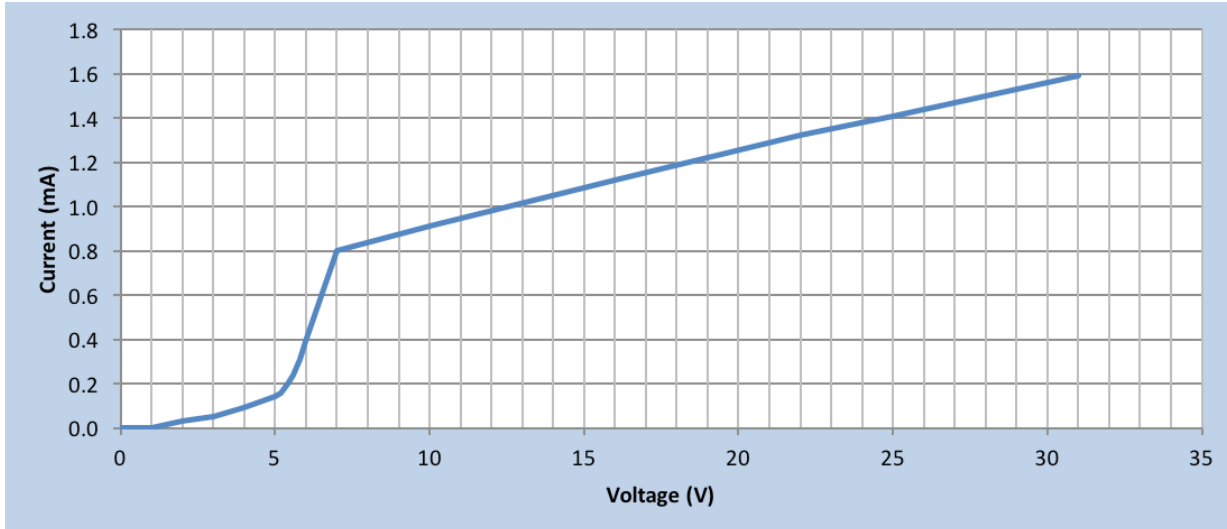

# Xitanium SR XI180C180V144VSF2

180W 120-277 1.8A SR with Auxiliary Supply

## Electrical Specifications

All specifications are typical and at 25°C Ta unless specified otherwise.

## Driver Lifetime Vs. Driver Case Temperature

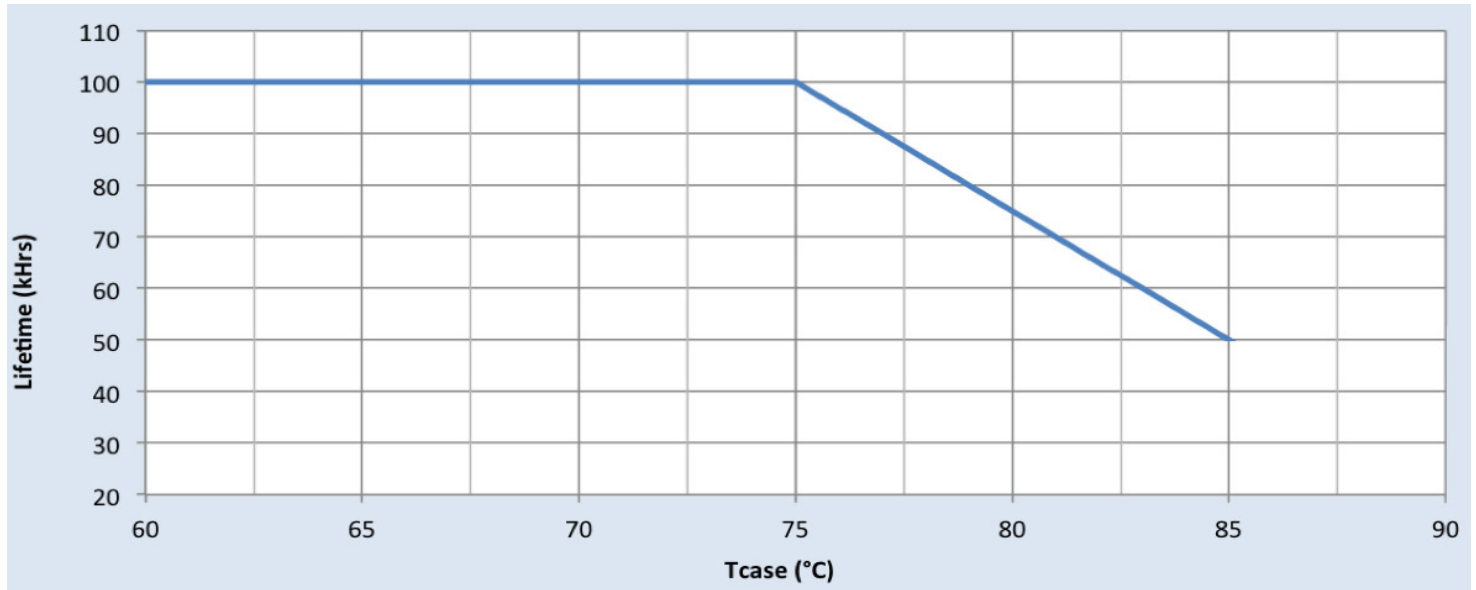

# Xtanium SR XI180C180V144VSF2

180W 120-277 1.8A SR with Auxiliary Supply

## Performance Characteristics

Based on measurements on a typical sample. The accuracy of the measurements is within the tolerance of the measurement instruments. The graphs are meant to be a guideline and not a specification. Data below at 70°C Tcase.

### Efficiency Vs. Output Voltage @ 120VAC Input

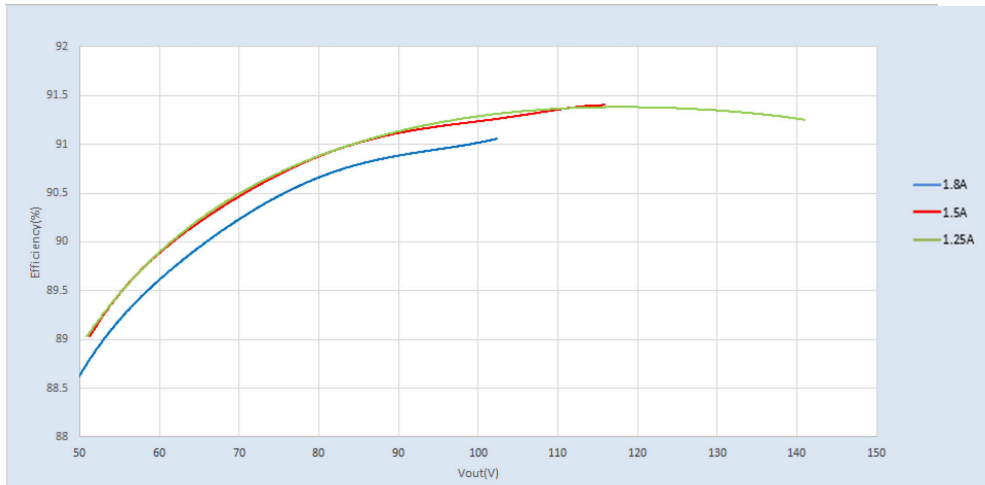

### Efficiency Vs. Output Voltage @ 277VAC Input

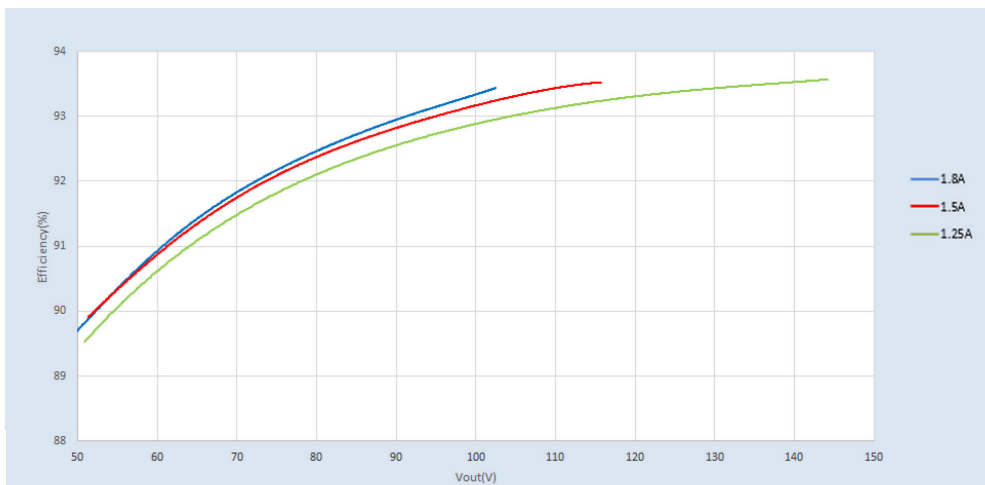



# Xitanium SR XI180C180V144VSF2

180W 120-277 1.8A SR with Auxiliary Supply

## Performance Characteristics

Based on measurements on a typical sample. The accuracy of the measurements is within the tolerance of the measurement instruments. The graphs are meant to be a guideline and not a specification. Data below at 70°C Tcase.

### Power Factor Vs. Output Power

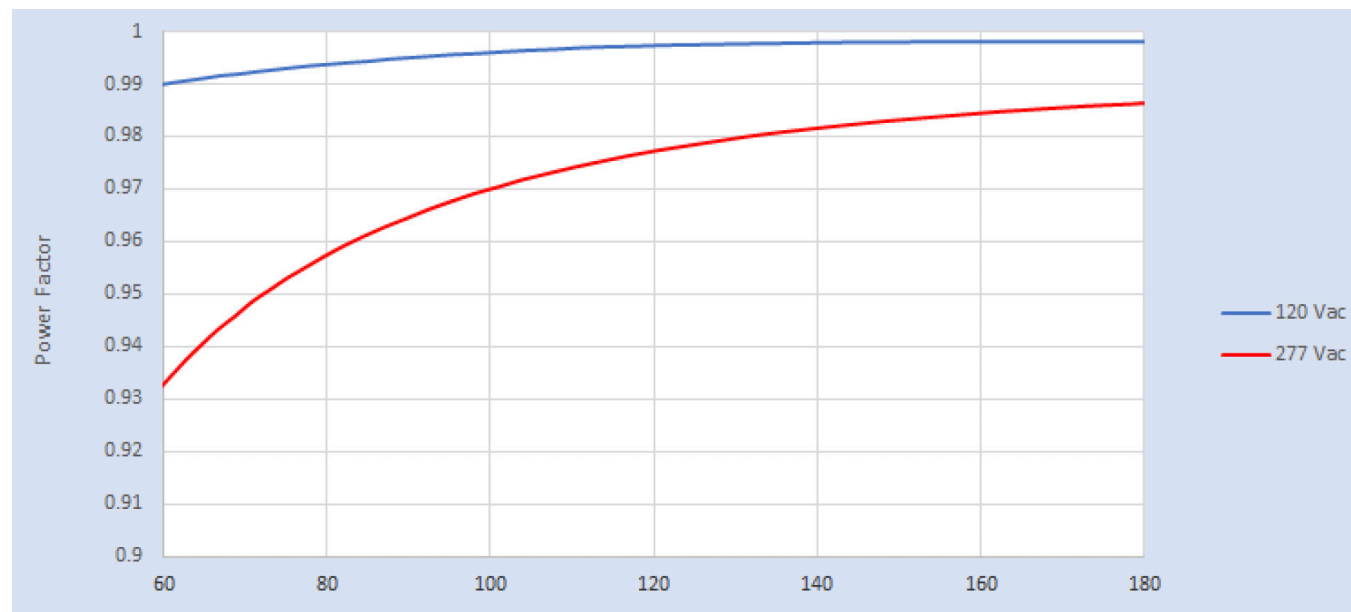

### Total Harmonic Distortion Vs. Output Power

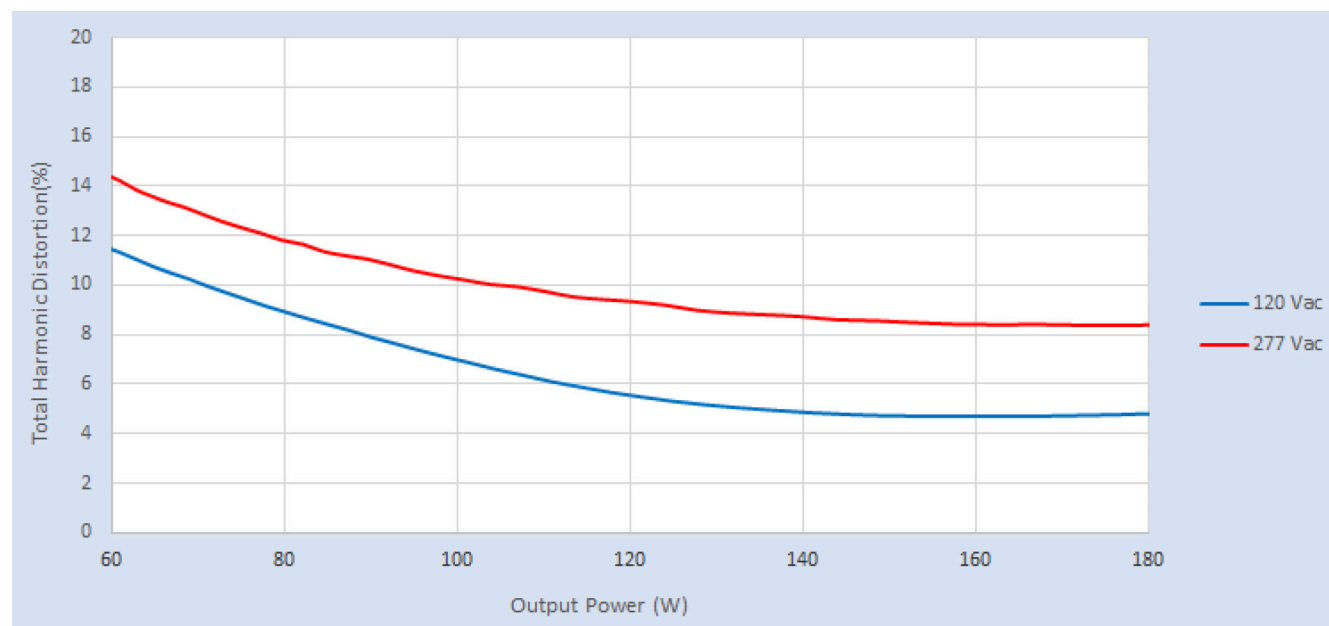

Total Harmonic Distortion content is in compliance with ANSI C82.77-10 standard

# Xitanium SR XI180C180V144VSF2

180W 120-277 1.8A SR with Auxiliary Supply

## Inrush Current Info

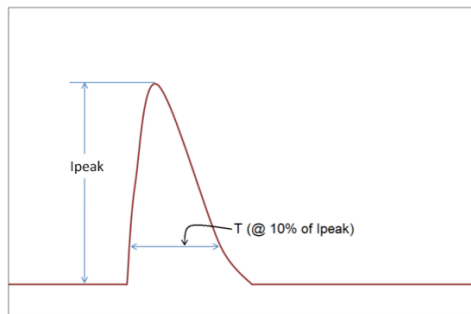

$V_{in}$	$I_{peak}$	T (@ 10% of $I_{peak}$ )
120 Vac	94A	200 $\mu$ s
277 Vac	220A	192 $\mu$ s

Inrush current is measured at peak of the corresponding line voltage, source impedance per NEMA 410.

## Lightning Surge Info

ANSI Surge Type	Differential Mode (L-N)	Common Mode (L-G, N-G, L&N-G)
Combination Wave (w/t 2 )	6kV	6kV

## Isolation

Isolation	Input Leads	Output Leads	SR leads (DA+,DA-/SGND, Aux and LSI), Class 2 only	Enclosure
Input Leads	NA	2xU+1kV	2xU+1kV	2xU+1kV
Output Leads	2xU+1kV	NA	2xU+1kV	2xU+1kV
SR leads (DA+,DA-/SGND, Aux and LSI), Class 2 Only	2xU+1kV	2xU+1kV	NA	500 V
Enclosure	2xU+1kV	2xU+1kV	500 V	NA

U = Max. working voltage

